

**SOL.**

**KURUMSAL KİMLİK PROJESİ  
2014**

- Logo Ölçülendirme**
- Logo Detaylı Ölçülendirme**
- Yazı Karakteri**
- Renk Kodları**
- Devamblem**
- Kanopi**
- Fiyat Panosu**
- Monokolon Pompa**
- Bayrak Tipi Pompaüstü**
- Pompa Üzeri Armatür**
- Bina Alını**
- Giriş - Çıkış Panosu**
- Hizmet Ünitesi**
- Işıklı WC Panoları**
- Işıksız WC Panoları**
- Hava-Su Talimatları**
- Bayrak Direkleri**
- Afişetlik**
- Yol Yaklaşım Tabelası**
- İstasyon Genel Görüntüler**



**SOIL.**

Logo Boyutlandırması

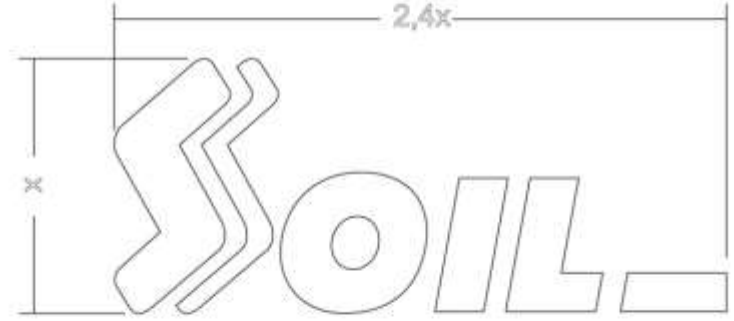

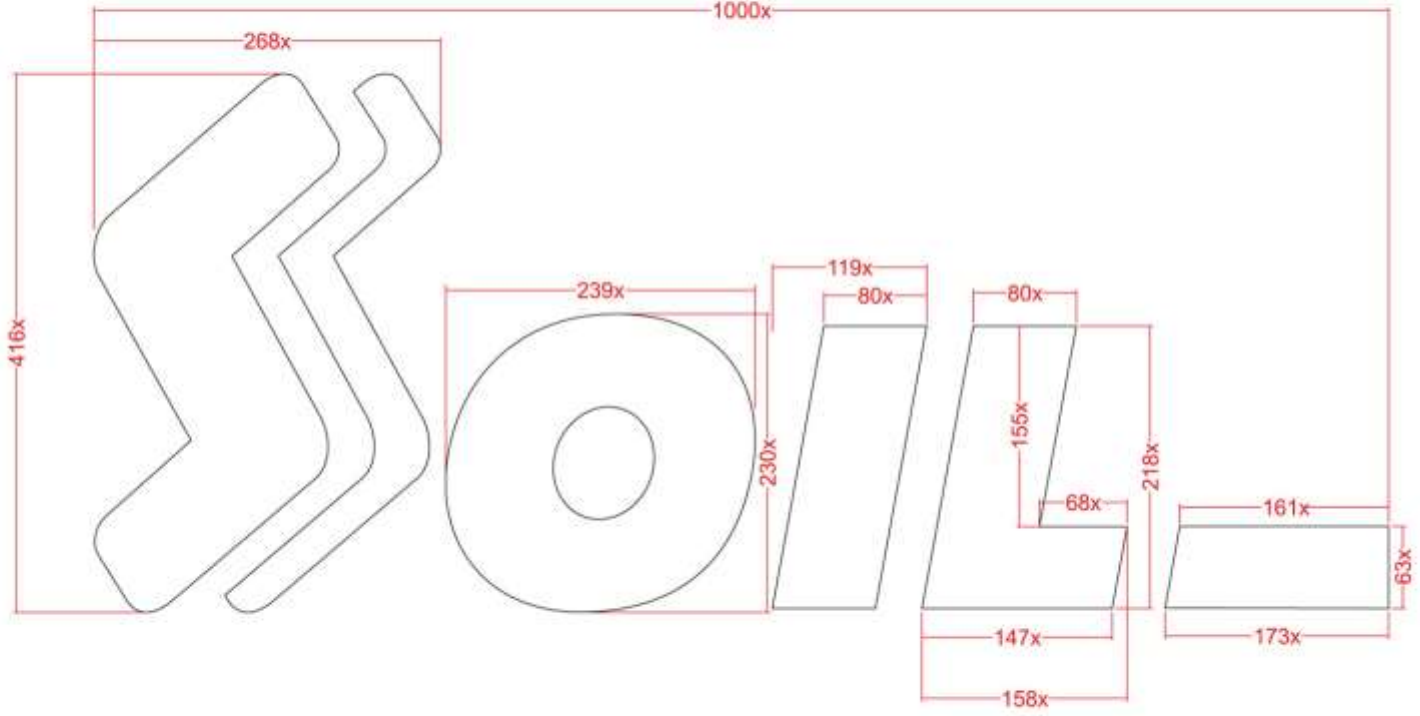

## Handel Got D Bold

ABCÇDEFGĞHIJKLMNOÖPRŞTUÜVYZQWX

abcçdefgğhijklmnoöprsštuüvyzqwx

0123456789

/\*-+!>^+>%&/()=?\_>€#\$ 1/2{[]}\|~

**BOYA****RAL 1023****RAL 9005****RAL 9006****RAL 9016****FOLYO****ORACAL-8100-021  
ORACAL-64I-022****ORACAL-65I-070  
ORACAL-64I-070****ORACAL-64I-090****ORACAL-64I-010**

Bu kurumsal kimlik kavuzu MTN Reklam tarafından Sijam Petroçelik A.Ş. için hazırlanmıştır. (Her hakkı saklıdır.)

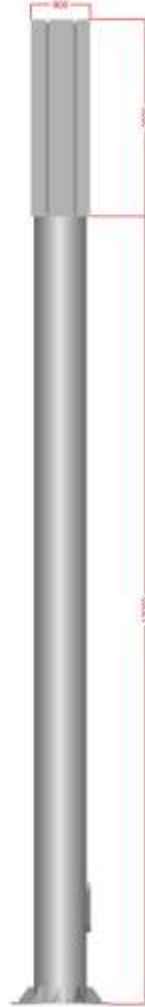
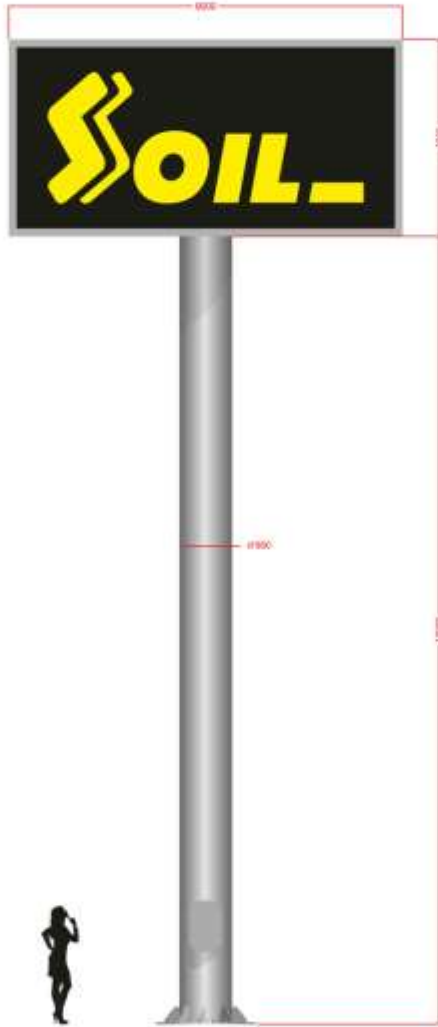

**ALT KESİT DETAYI**

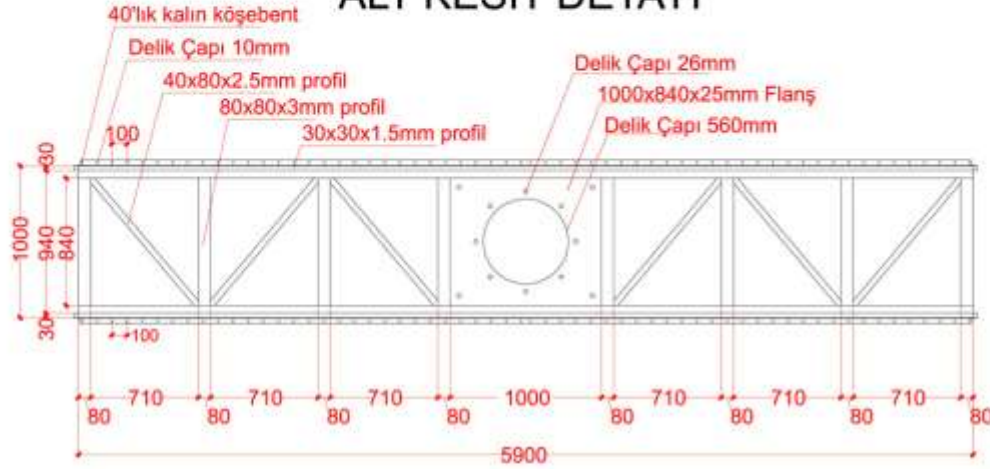

**ÜST KESİT DETAYI**

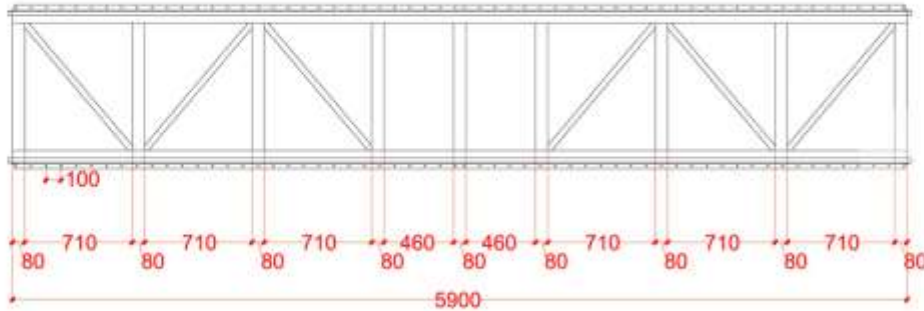

**YAN KESİT DETAYI**

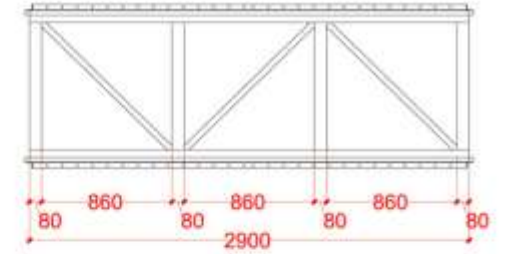



BALAST TAVASI

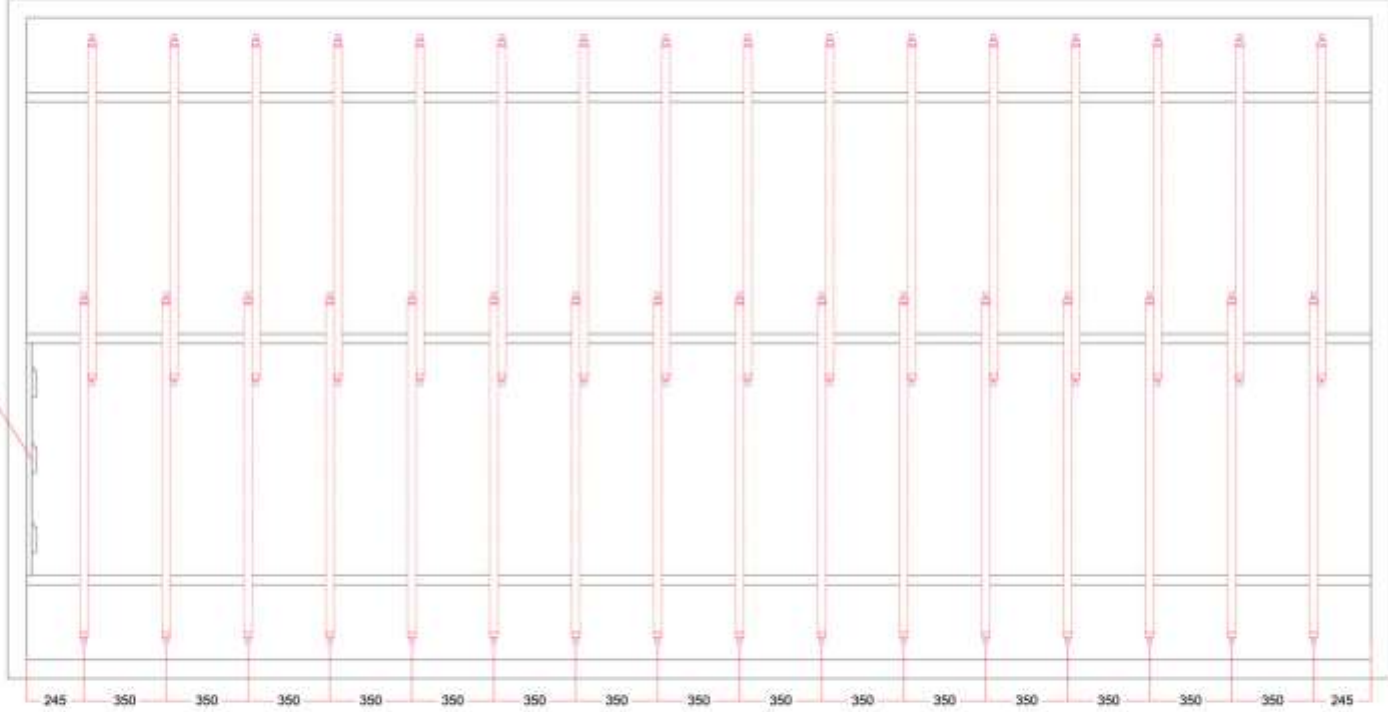

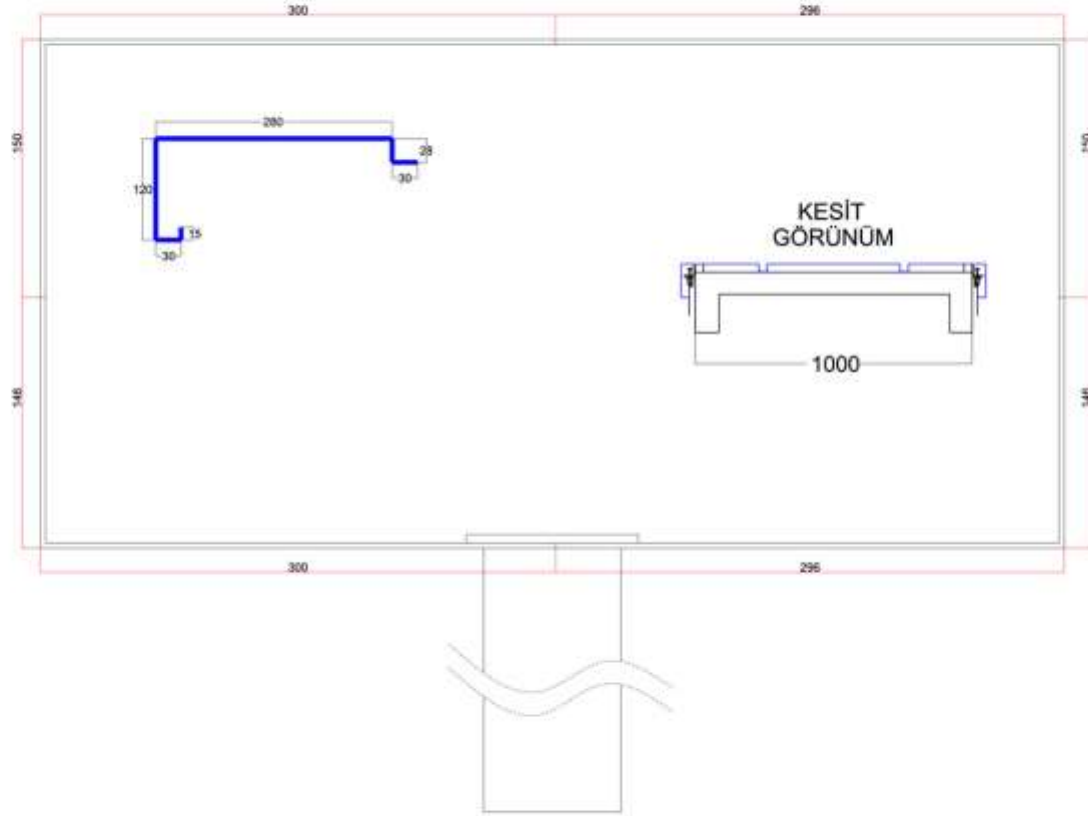

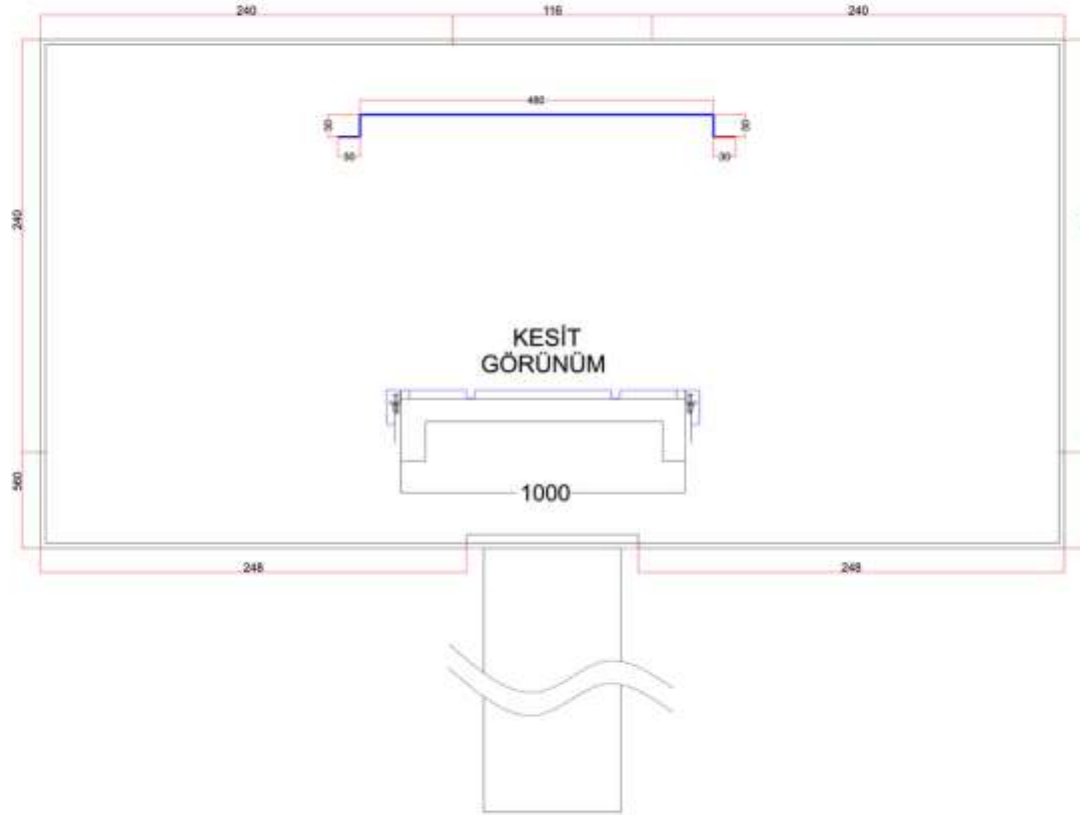

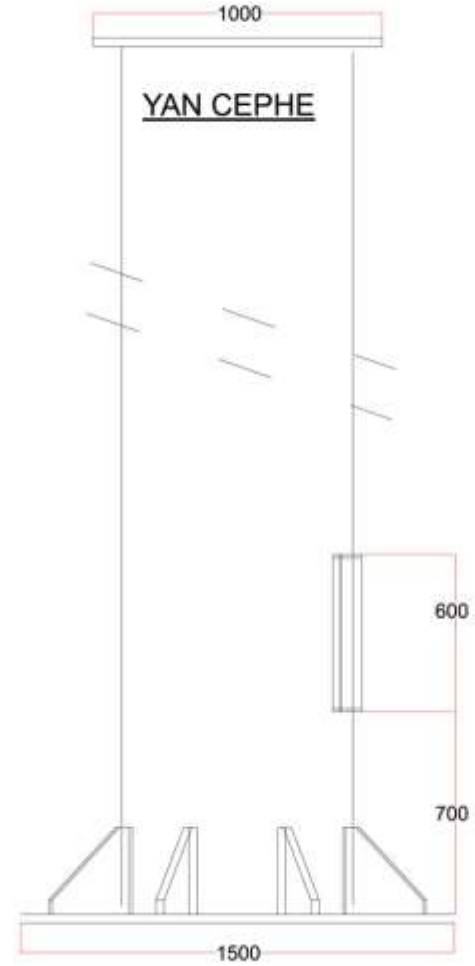
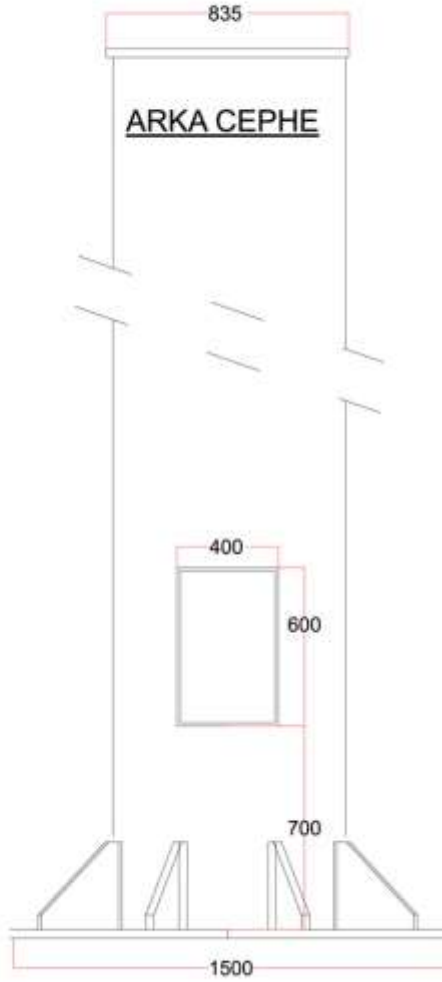

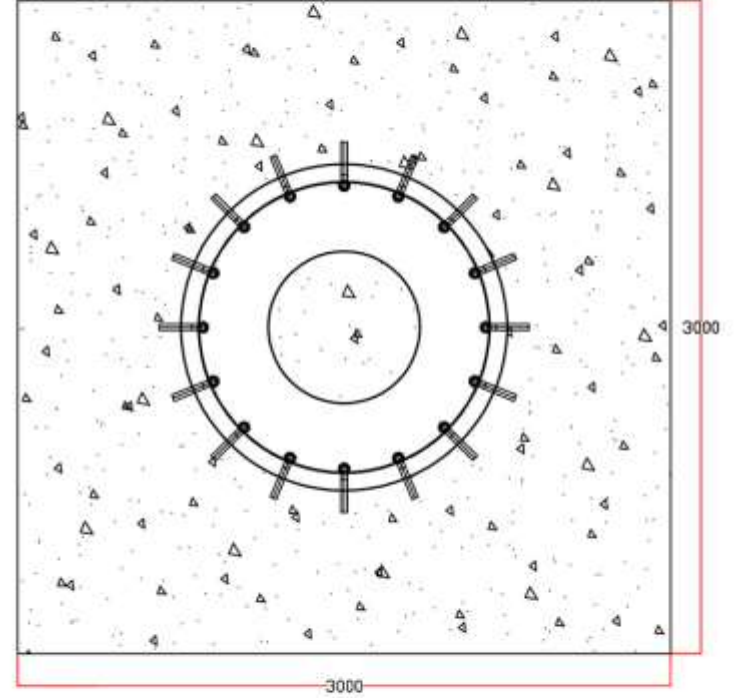
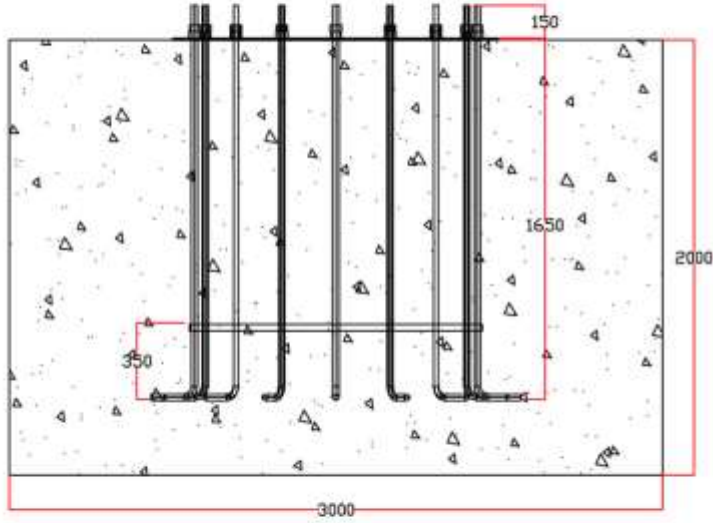

### DEV AMBLEM; 3000x6000

3000X3000X2000mm demir donatılı beton temele monte edilecektir. Beton C20 kalitede olacaktır. Betonun üstten 20cm.lik kısmı kalıplı olacaktır.

Boru, 8 ve 10 mm kalınlıkta saclardan kıvrılarak oluşturulacaktır. Boruların birleşim yerlerine içten 8 mm kalınlığında 200mm genişliğinde takviye sacı dönülecektir. Taban flanşı 1500X1200X30 mm ebatlarında, üst flanş 1500X800X30mm ebatlarında olacaktır. Ankraj M30 mm lik transmisyondan üretilecektir. Temel somunları kontra olacak şekilde sıkılacaktır. Direk içerisinde servis merdiveni ve alt kısmında menhol kapağı bulunacaktır. Direk içi antipas, RAL 9006 ile boyanacaktır.

Kaset, Konstrüksiyonu NPL 100, NPL 80, NPL 40 ve NPU 180 çelik profillerden üretilecektir.

Kaplamalar 1,5mm galvaniz levhaya form verilerek oluşturulacak, soil sarı rengine boyanacaktır.

Aydınlatma 50 adet 36w floresant ile sağlanacaktır. Linyeler trifaze sisteme göre dağıtılacak ve PVC kablo kanalı içinden geçecektir. Ana linye 4x4 mm kesitinde, tali linyeler 4x2.5 mm olacaktır. Lambalar soket ile bağlanacaktır. Lamba tespitlerinde plastik ay kullanılacaktır. Balast ve starterler bakım kolaylığı sağlayacak şekilde yerleştirilecektir. Topraklama ile techiz edilecektir. Topraklama çubuğu, çap:18mm olup boyu 1000mm'dir. Topraklama çubuğuna bağlanan kablo 8mm olup tüm malzeme bakır olacaktır. Çubuğu sabitleyen kelepçe de bakır malzemedir. Yüzejde beyaz vinil üzerine ışık geçirgen folyo kullanılacak, vinil özel

alüminyum gergi aparatlarıyla gerilecektir. Vinil malzemesi tek parça (dikişsiz) olarak kullanılacaktır.

**SOIL\_**

Kanopi

Bu kurumsal kimlik ilavesi MTN Reklam tarafından Sijam Petrolcük A.Ş. için hazırlanmıştır. (Her hakkı saklıdır.)



100

300



**SOIL-**

Kanopi

Bu kurumsal kimlik kavramı MTN Reklam tarafından Sijam Petroçölük A.Ş. için hazırlanmıştır. (Her hakkı saklıdır.)

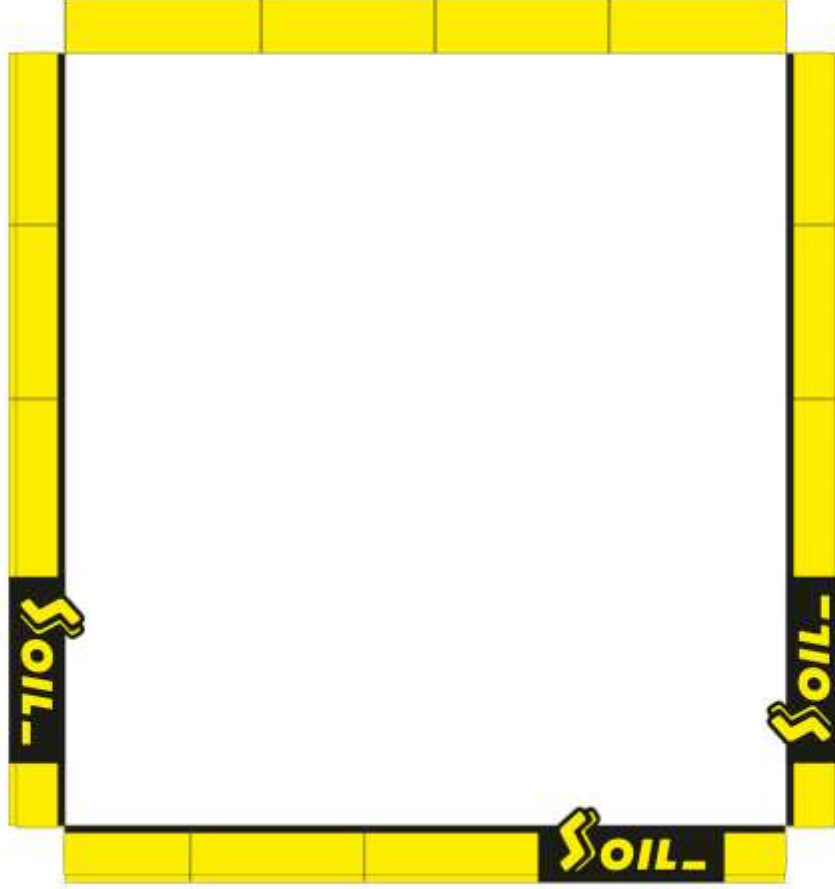



**SOIL**

## Kanopi Alın Logo Ölçüler

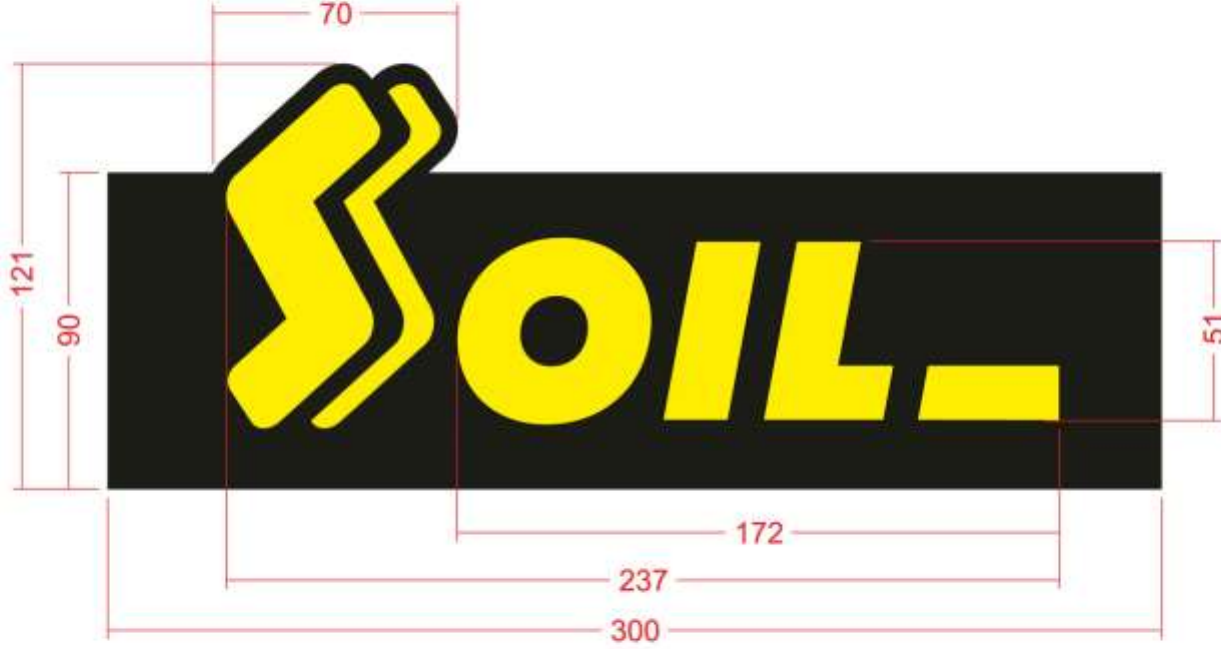

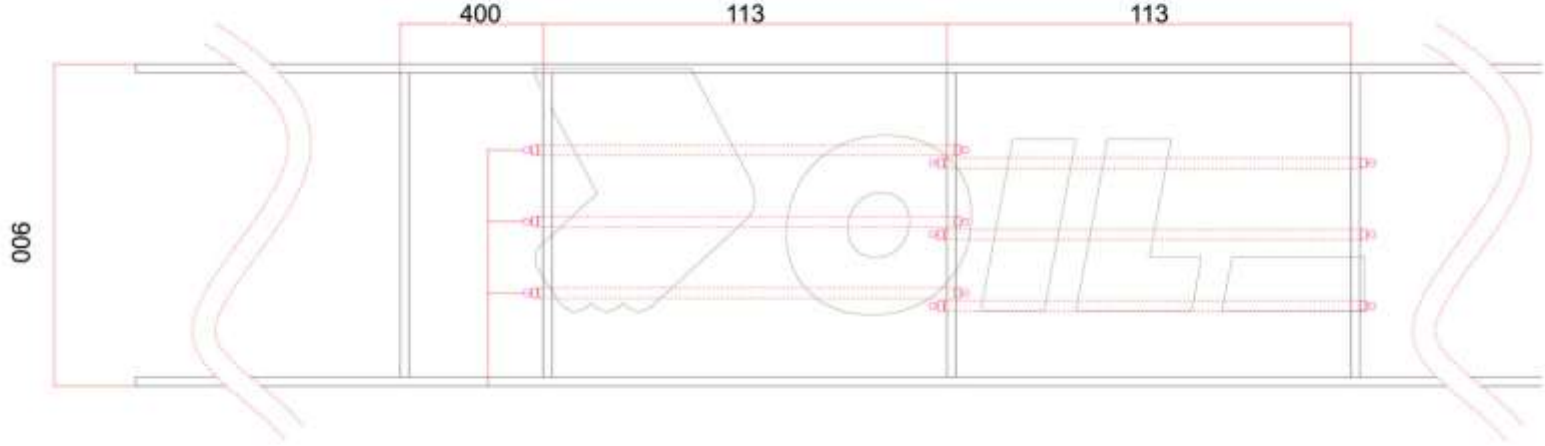

Bu kurumsal kimlik kavuzu MTN Reklam tarafından Sijam Petroçelik A.Ş. için hazırlanmıştır. (Her hakkı saklıdır.)

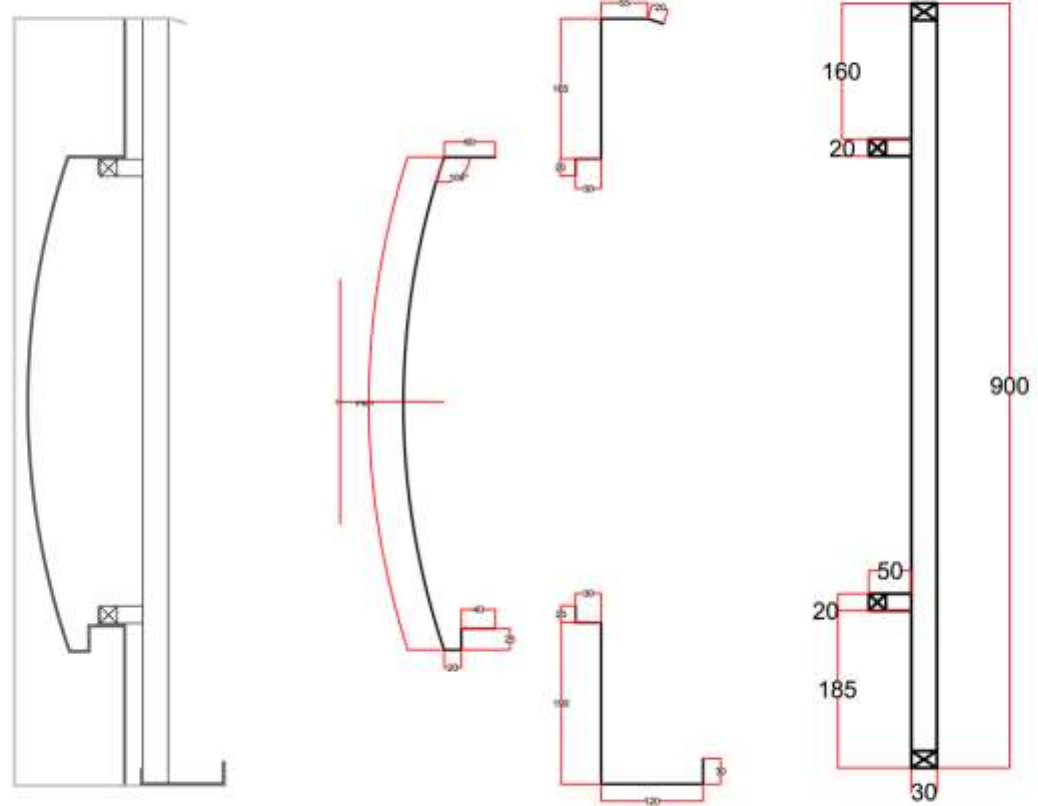

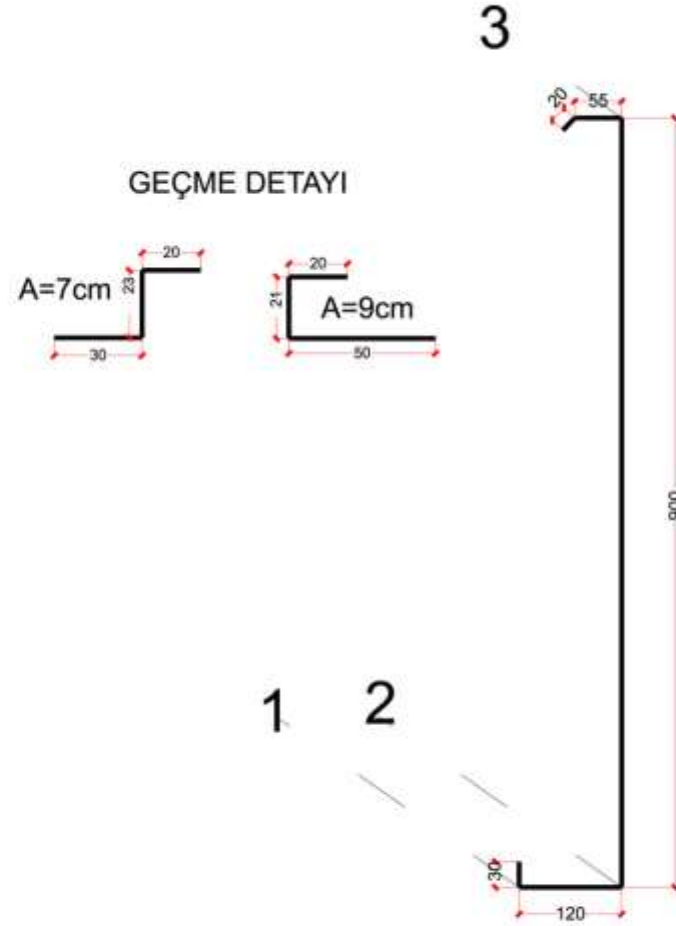

NOT: 1. ve 2. ÖLÇÜLER BÜKÜLDÜKTEN SONRA 900 mm ALINIP İŞARETLENECEKTİR. Ve BU İŞARETTEN 3. BÜKÜM YAPILACAKTIR.

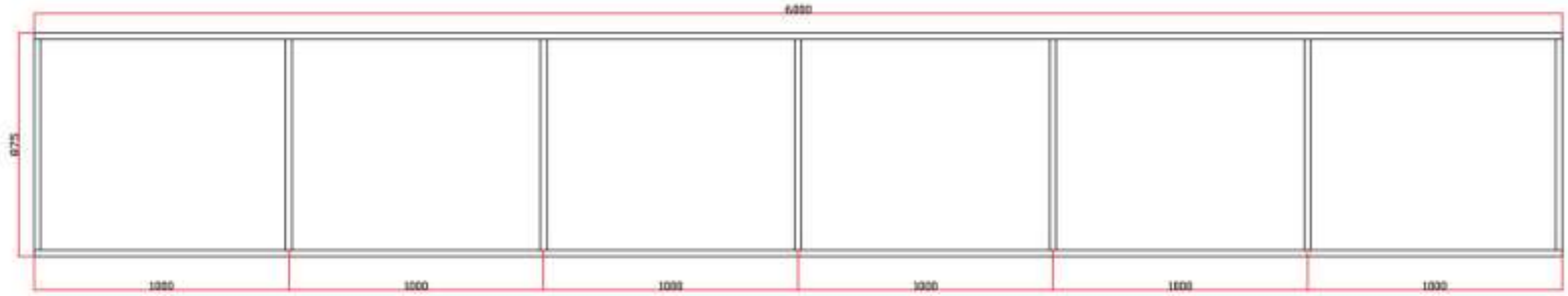

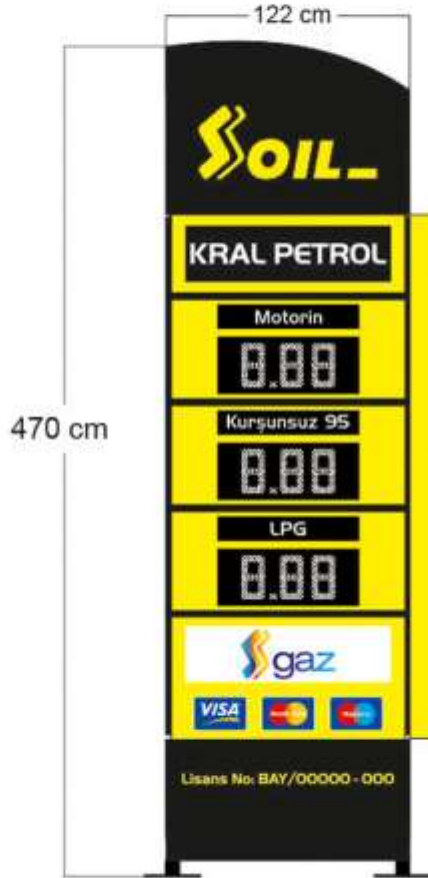





Kolon üzeri ikaz levhası  
Alüminyum üzeri folyo uygulama



Kolon üzeri iletişim levhası  
Alüminyum üzeri folyo uygulama





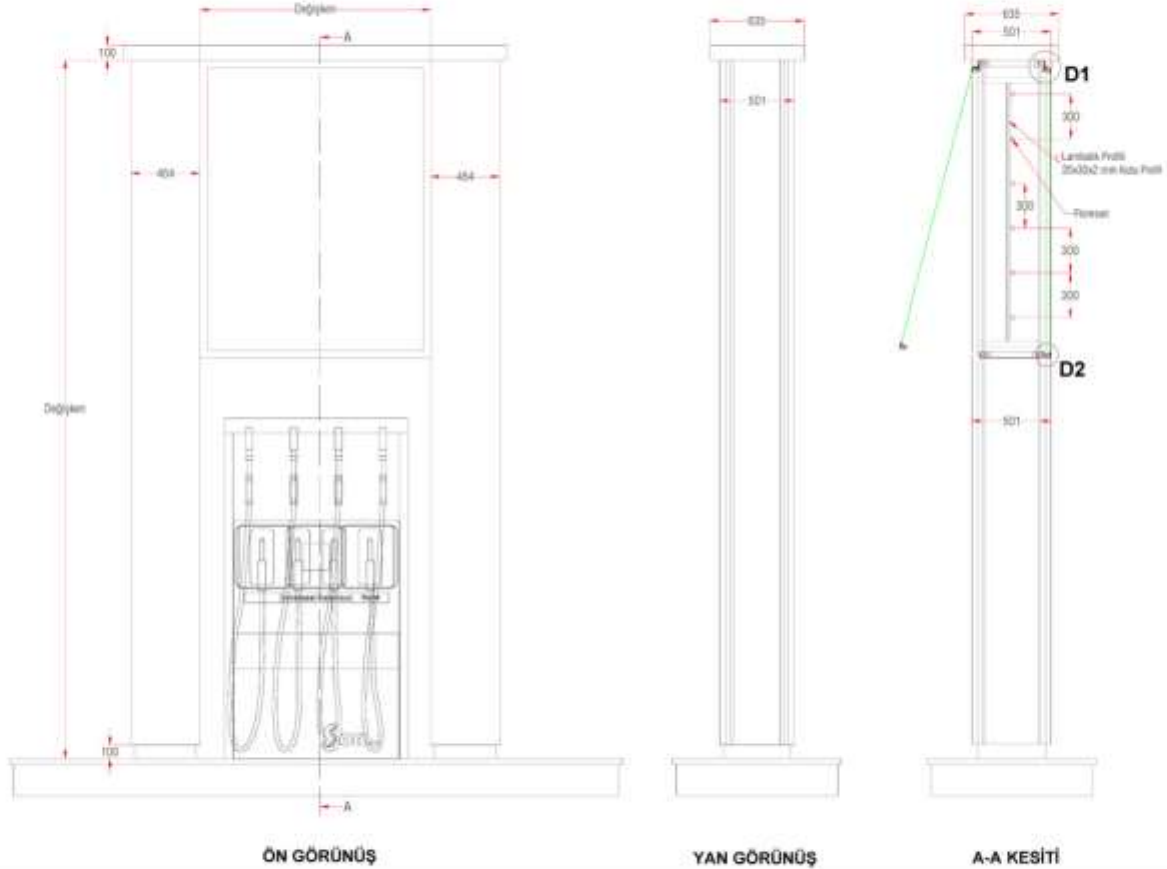

**SOIL**

## Bayrak Tipi Pompaüstü

Bu kurumsal kimlik klavuzunu MTN Reklam tarafından Sijam Petrolcülük A.Ş. için hazırlanmıştır. (Her halde saklıdır.)

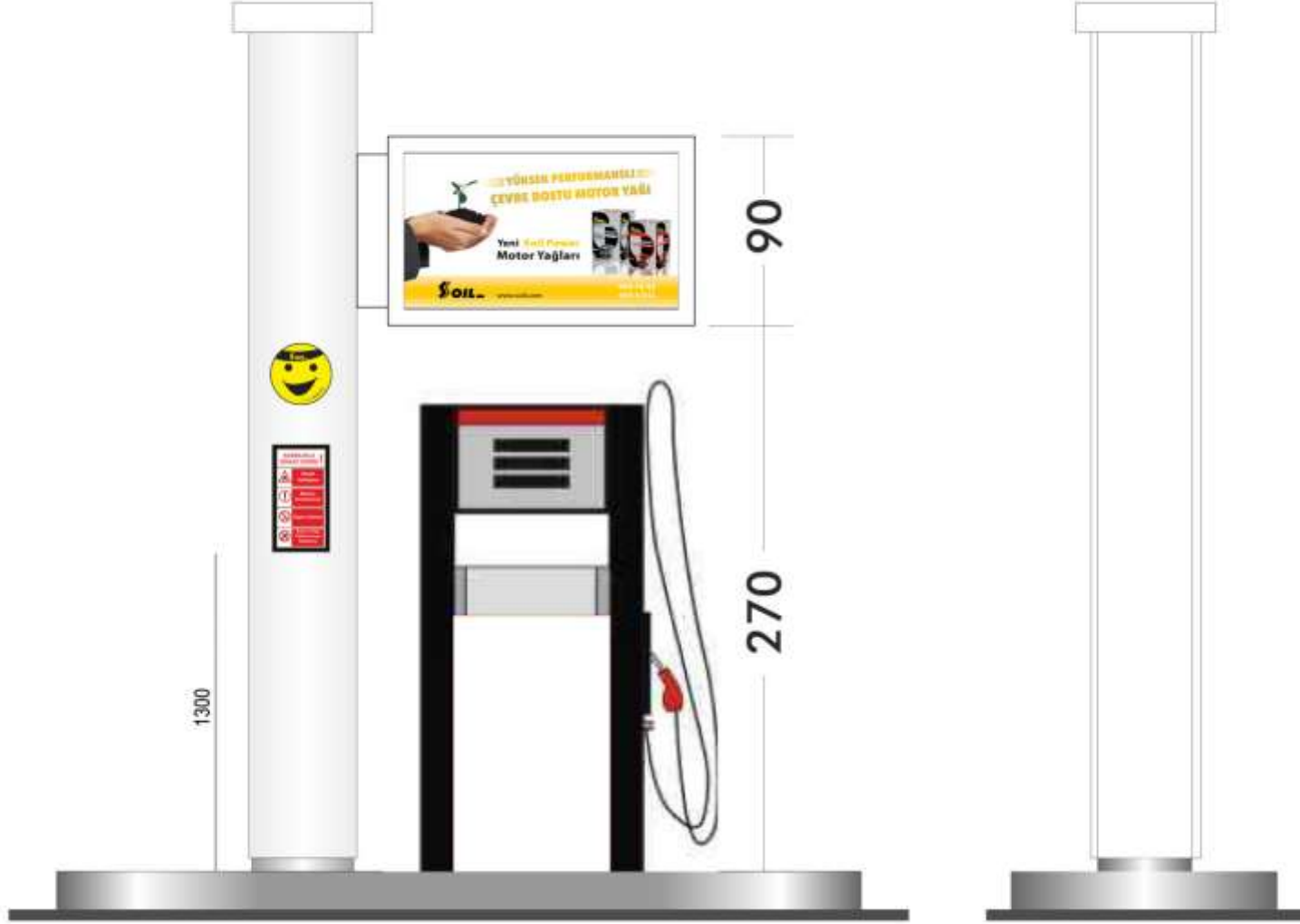



**YÜKSEK PERFORMANSLI  
ÇEVRE DOSTU MOTOR YAĞI**

Yeni **Soil Power**  
Motor Yağları

**SOIL** [www.soil.com](http://www.soil.com) 444 76 45  
444 SOIL

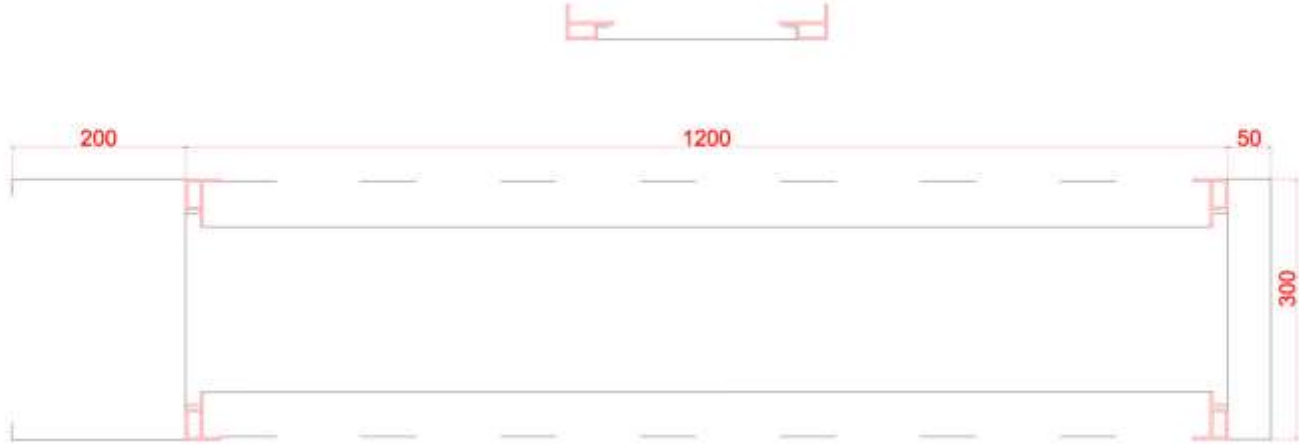

**h:75 cm**

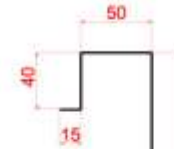

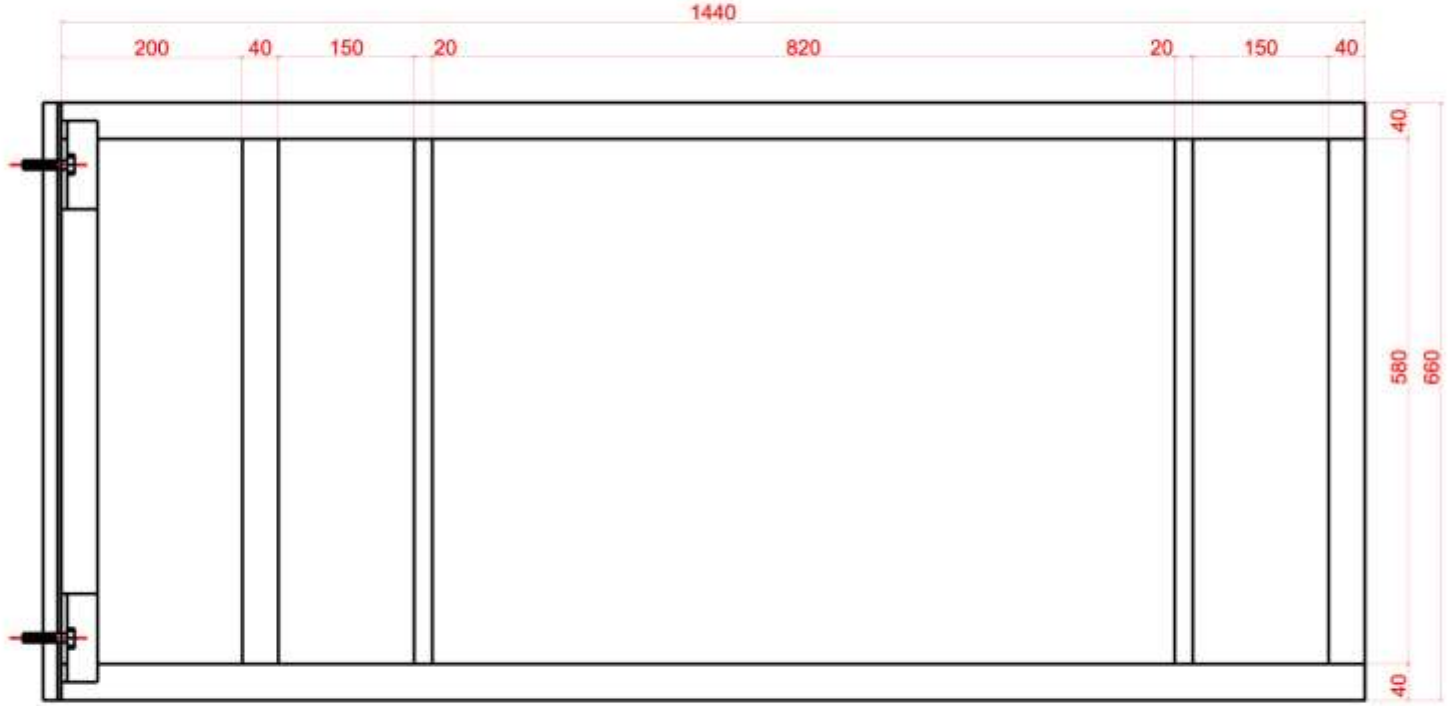

Bu kurumsal kimlik kavuzu MTN Reklam tarafından Sijam Petrolcılık A.Ş. için hazırlanmıştır. (Her halka aittir)

Bu kurumsal kimlik klavuzu MTN Reklam tarafından Sijam Petroçölük A.Ş. için hazırlanmıştır. (Her hakkı saklıdır.)



Bu kurumsal kimlik klavuzunu MTN Reklam tarafından Sijam Petrolçülük A.Ş. için hazırlanmıştır. (Her halde asıllıdır.)

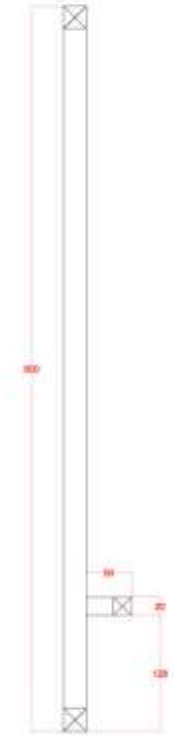
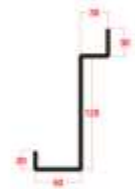

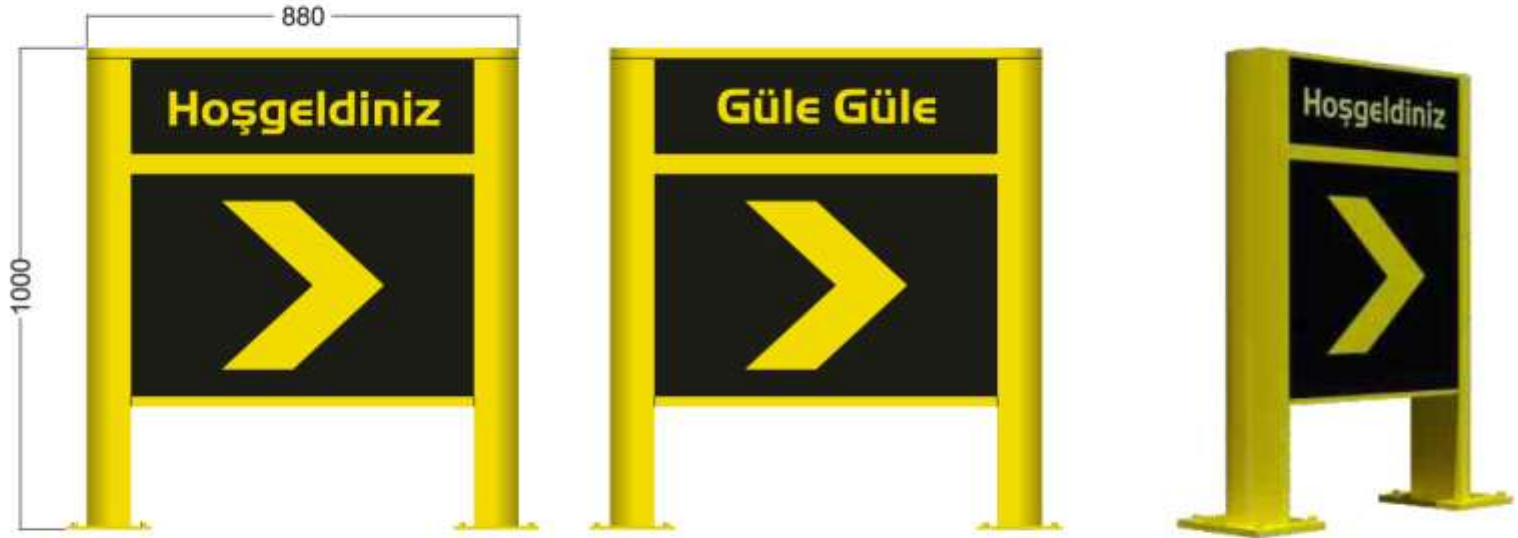



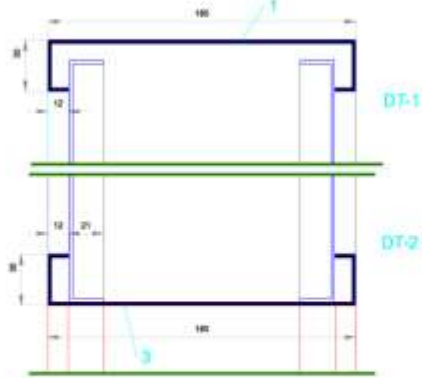
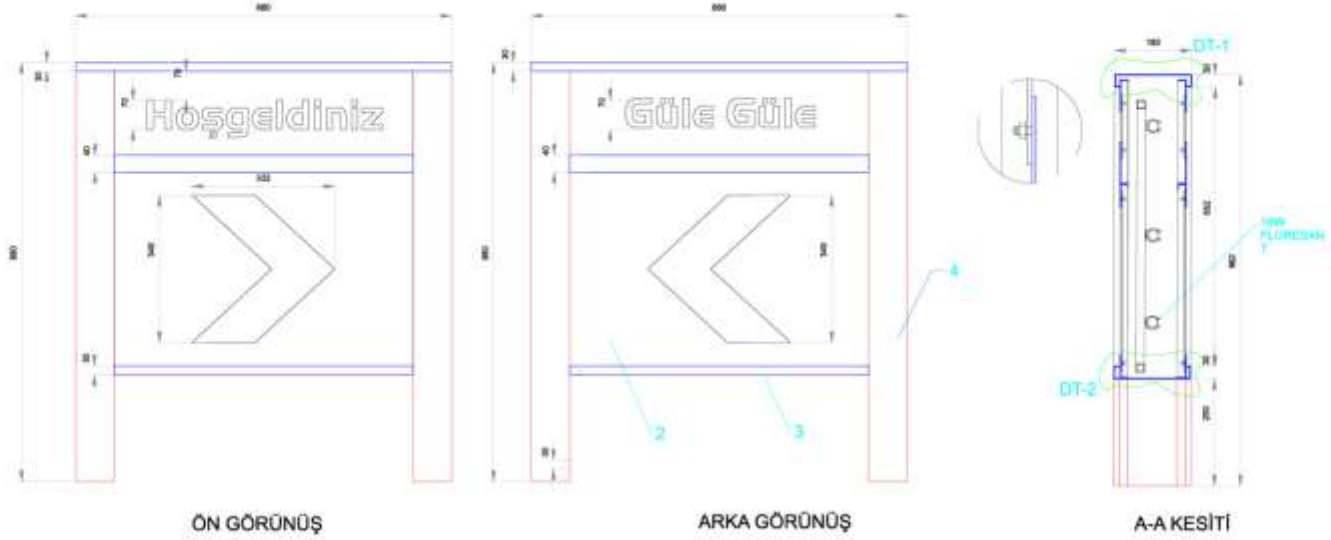

DT1 ve DT2 Detayları

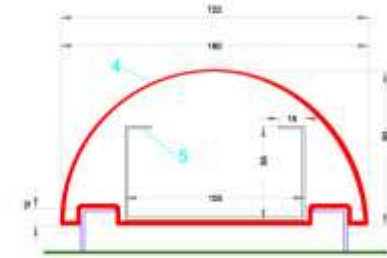
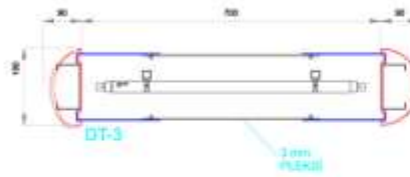

01	MONTAJ AYAKI	Çelmeçli Sac	1,5 mm	
04	PAS ANAĞI	ALÜMİNYUM PRO.		
03	ALT KAPLAMA	ALÜMİNYUM	2 mm	
02	ÖN KAPRI	ALÜMİNYUM	2 mm	
01	ÜST KAPLAMA	ALÜMİNYUM	2 mm	
PRO. NO	YERİ	KESİTİ	BAĞLARI	SEVİ
				HİÇBİRİ

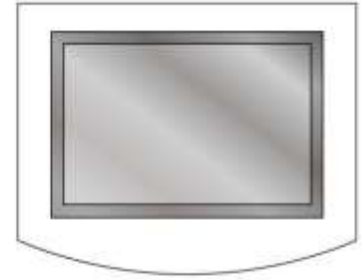

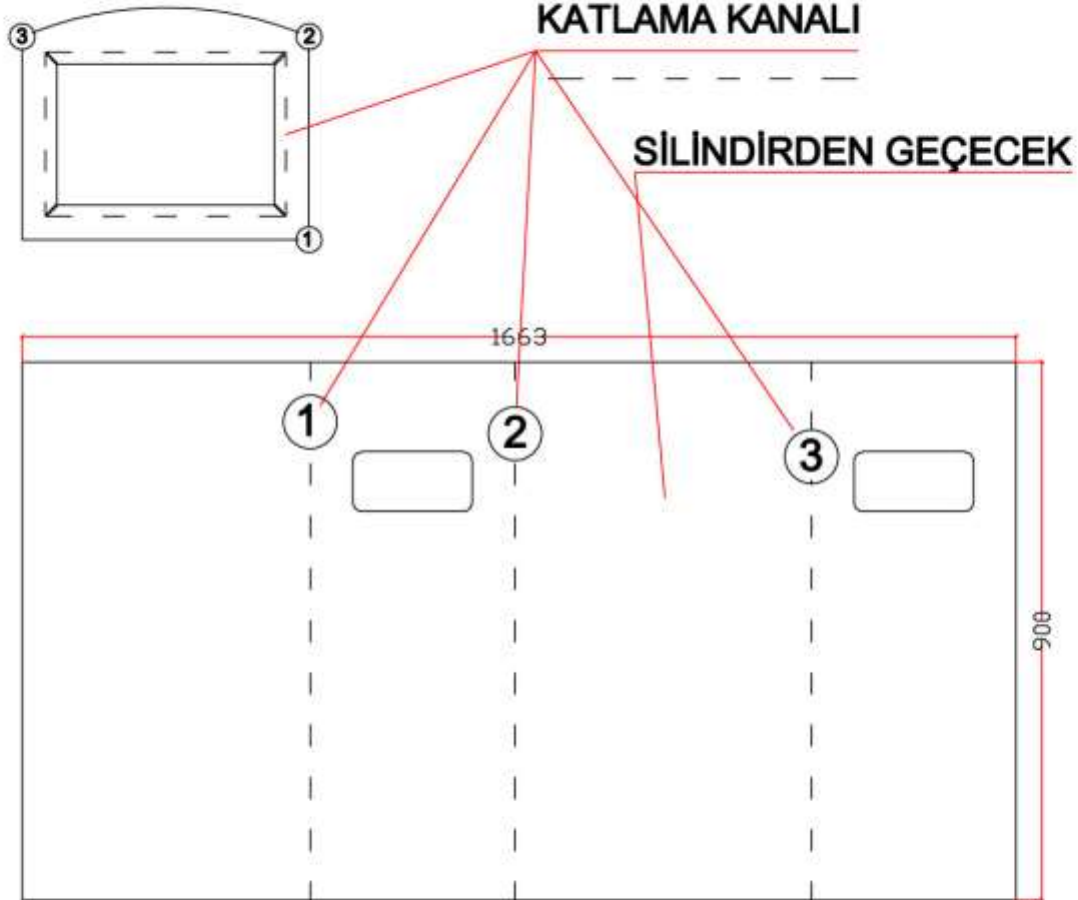

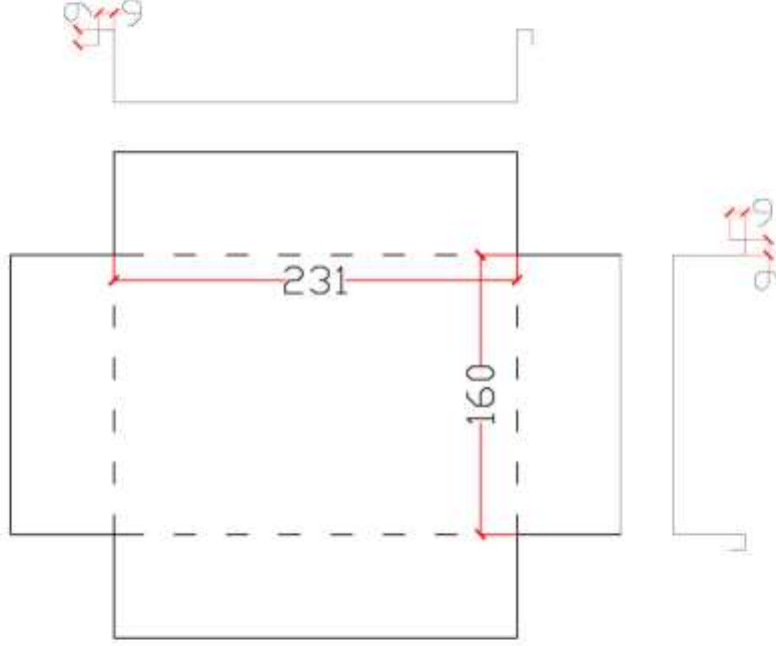

KULP

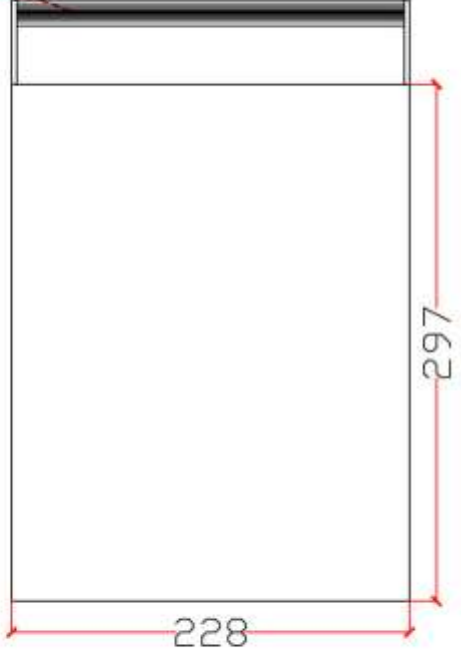

TABAN

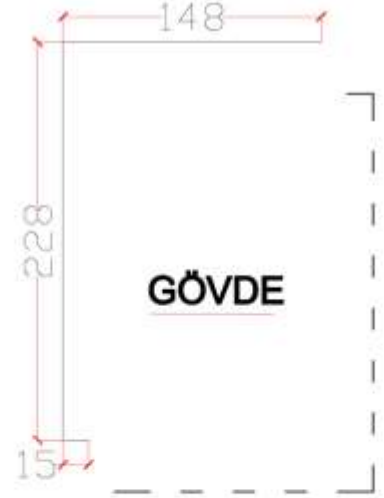
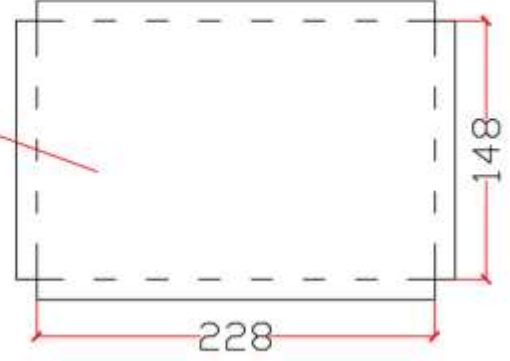

GÖVDE



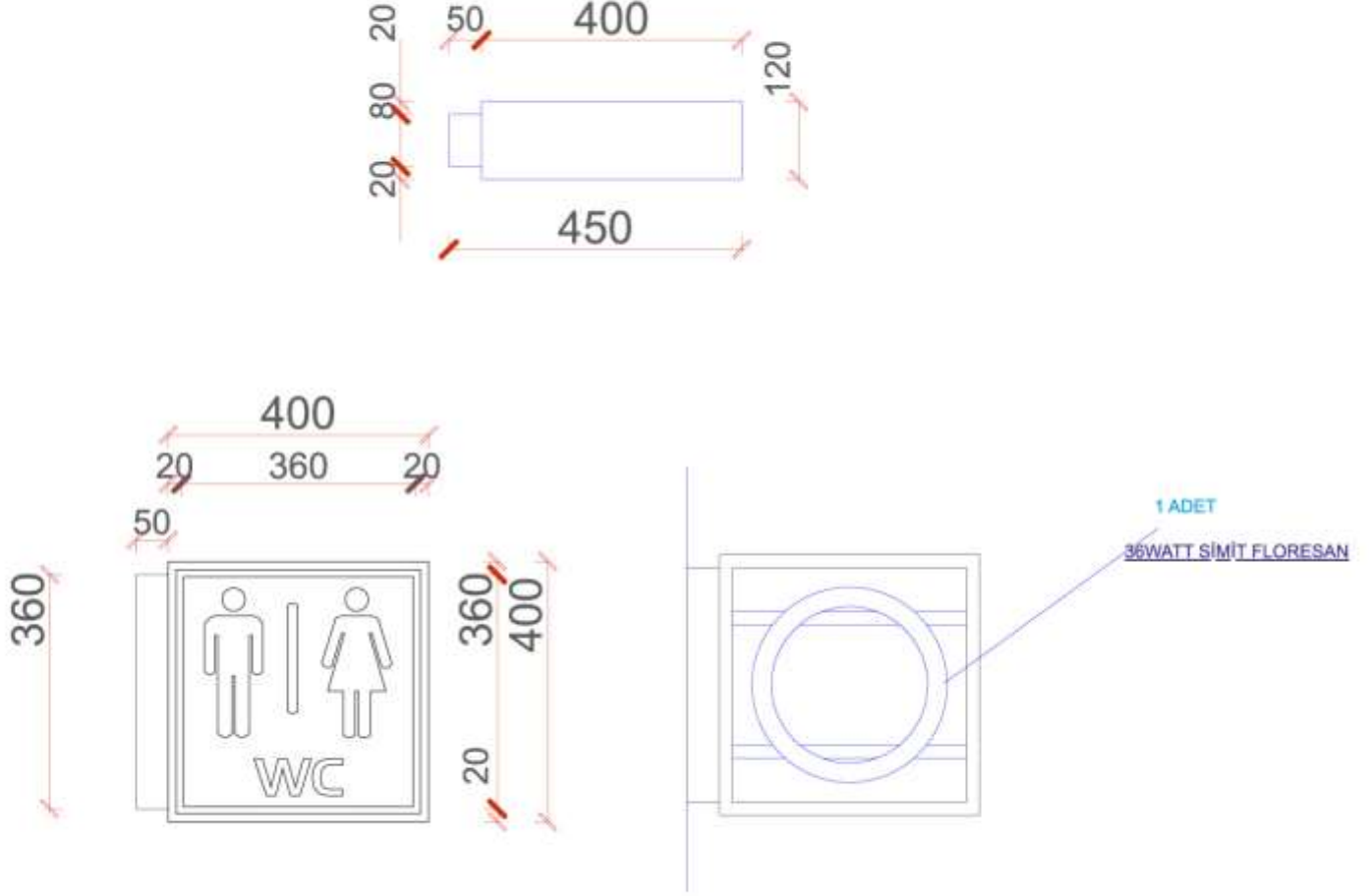

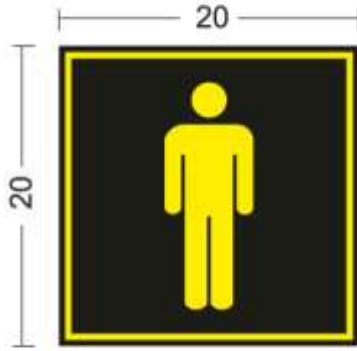





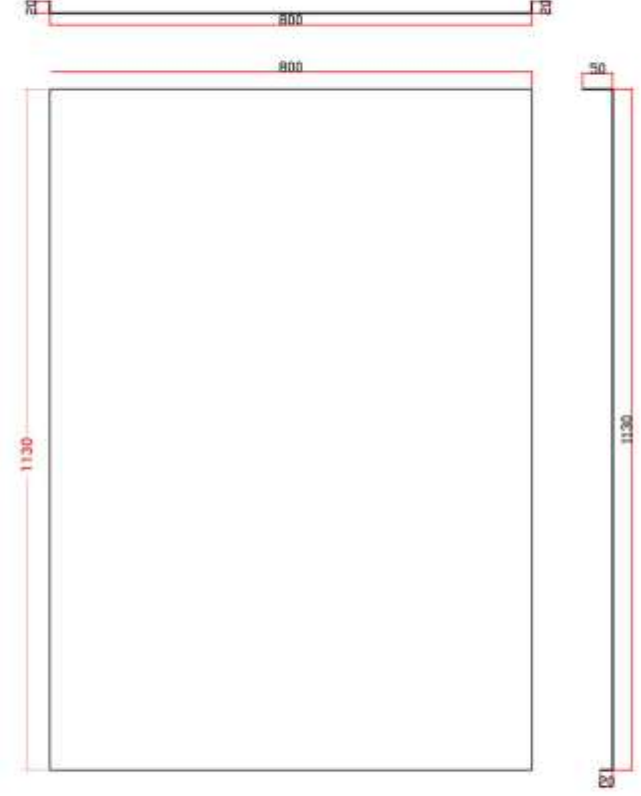
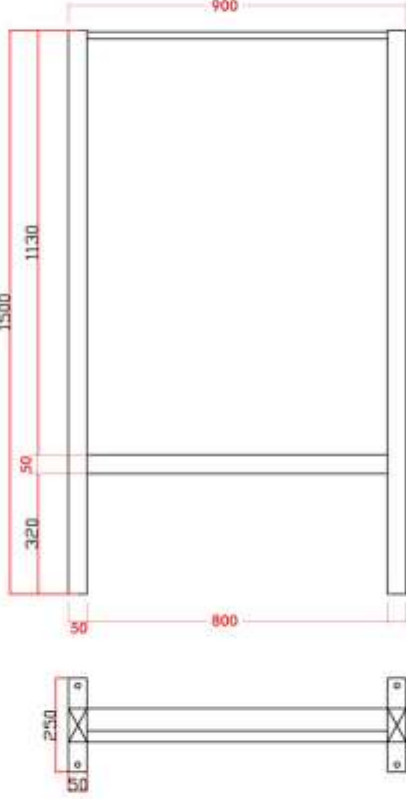

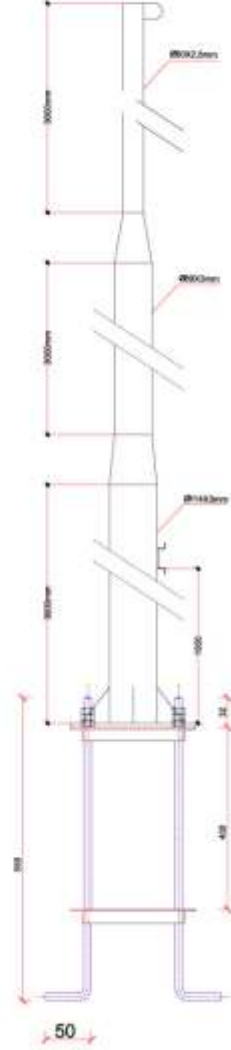

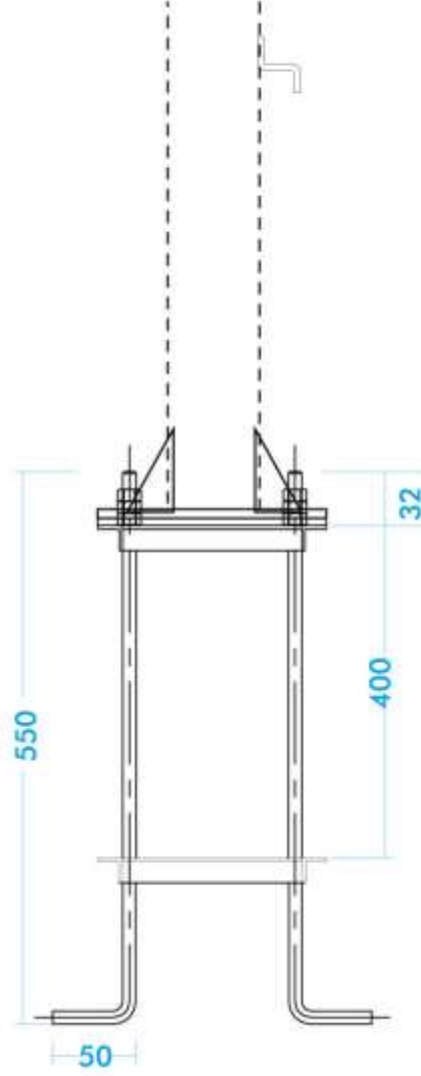

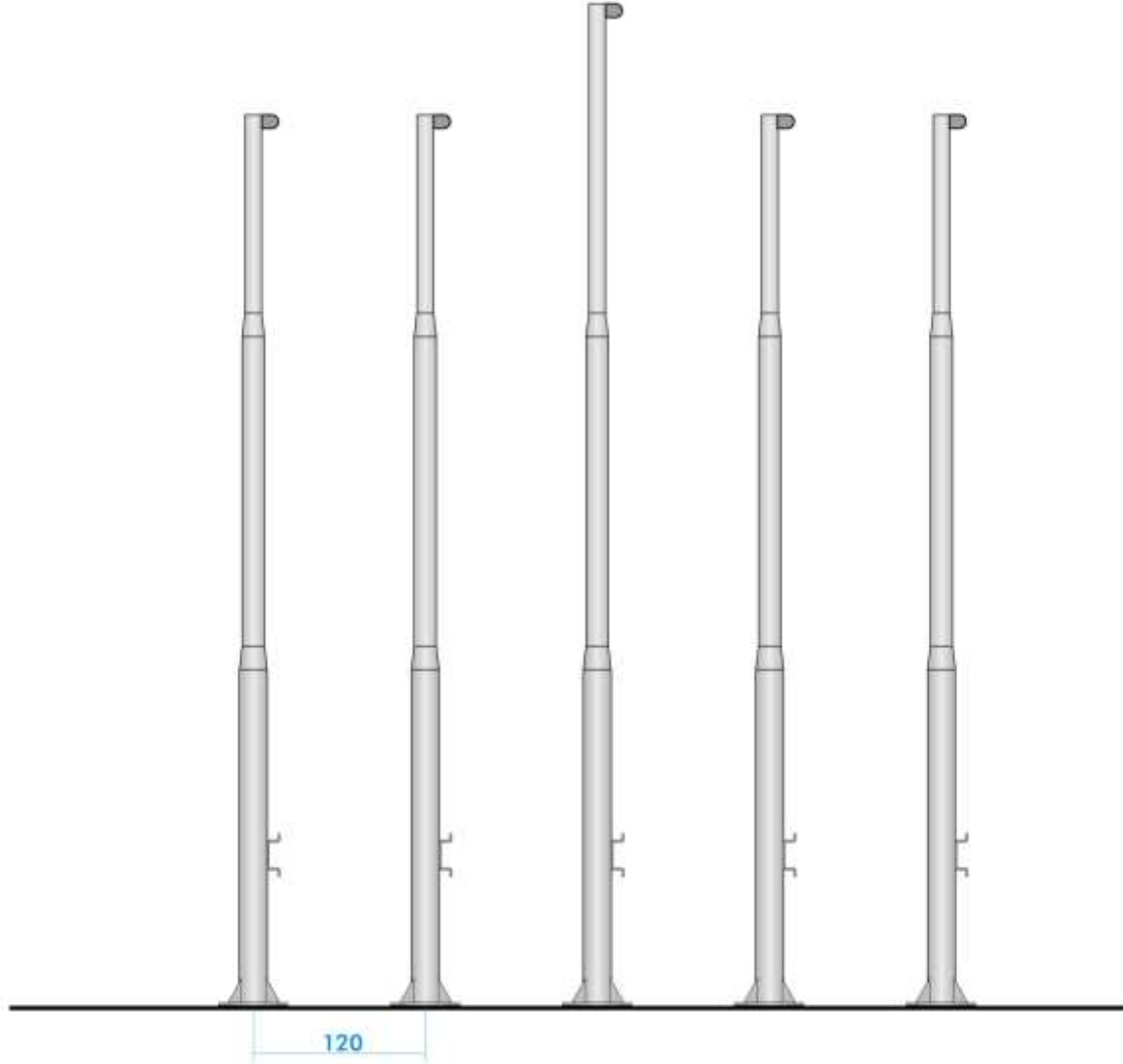

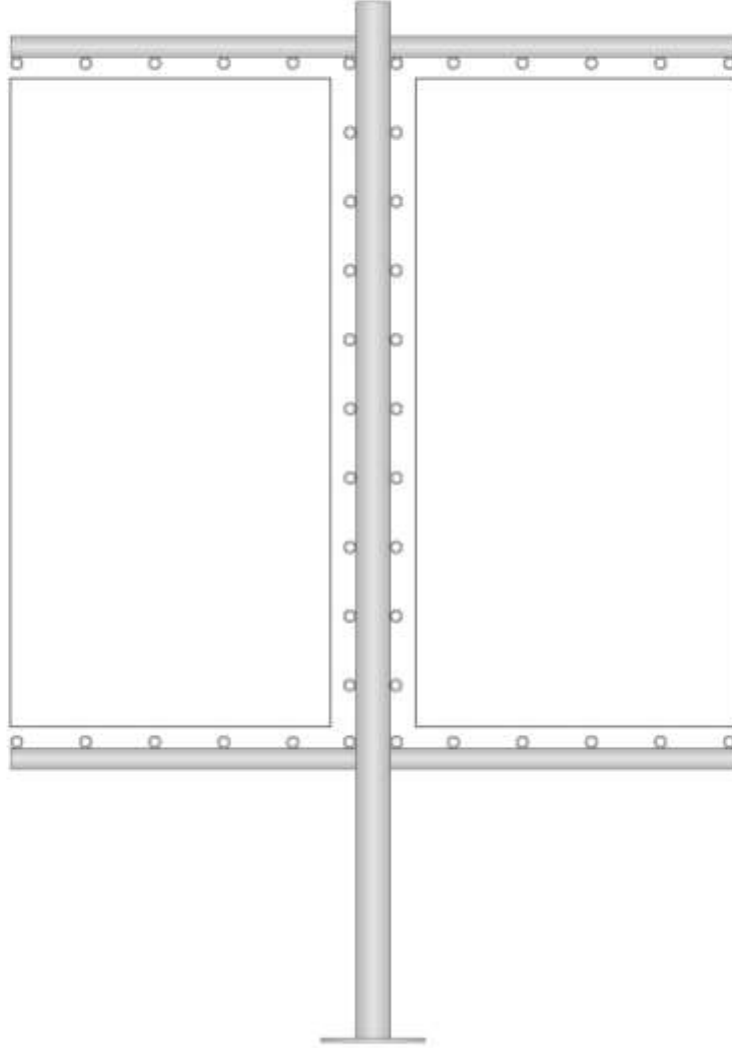

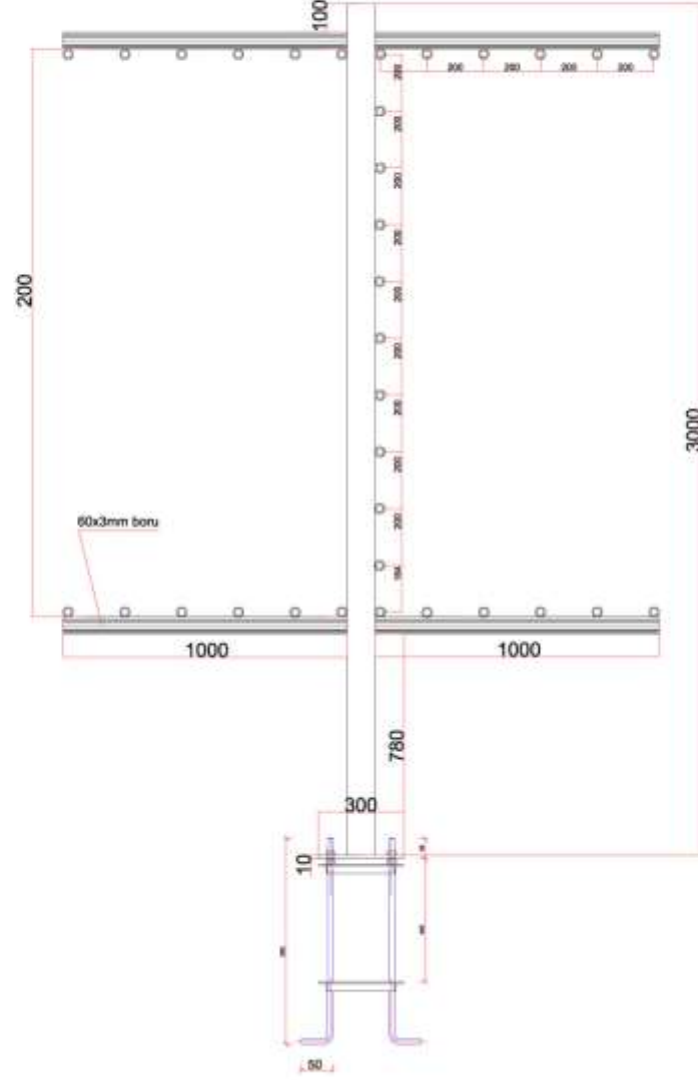

**SOIL**

Yol Yaklaşım Panosu



Bu kurumsal kimlik klavuzu MTN Reklam tarafından Sijam Petrolcılık A.Ş. için hazırlanmıştır. (Her halde saklıdır)





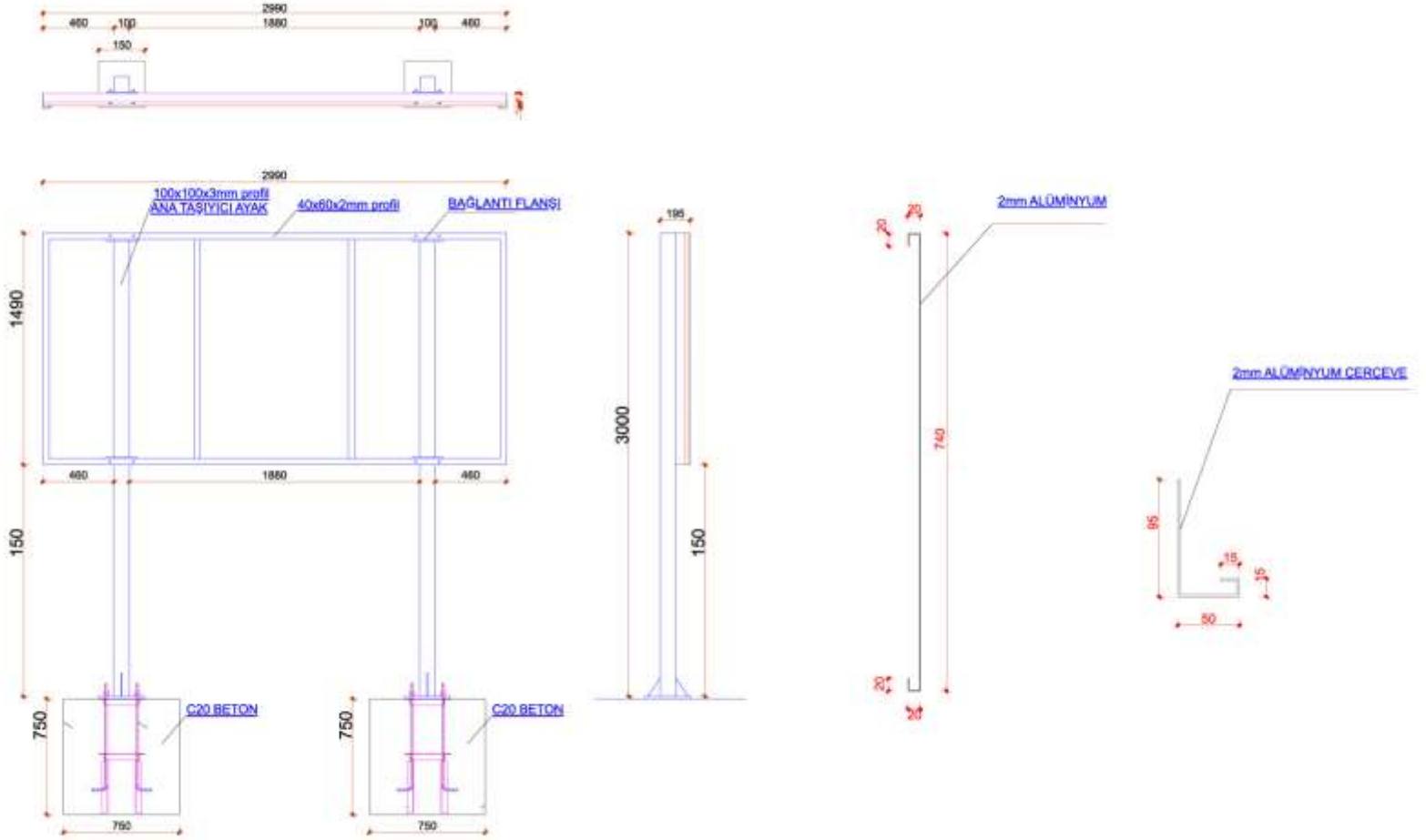

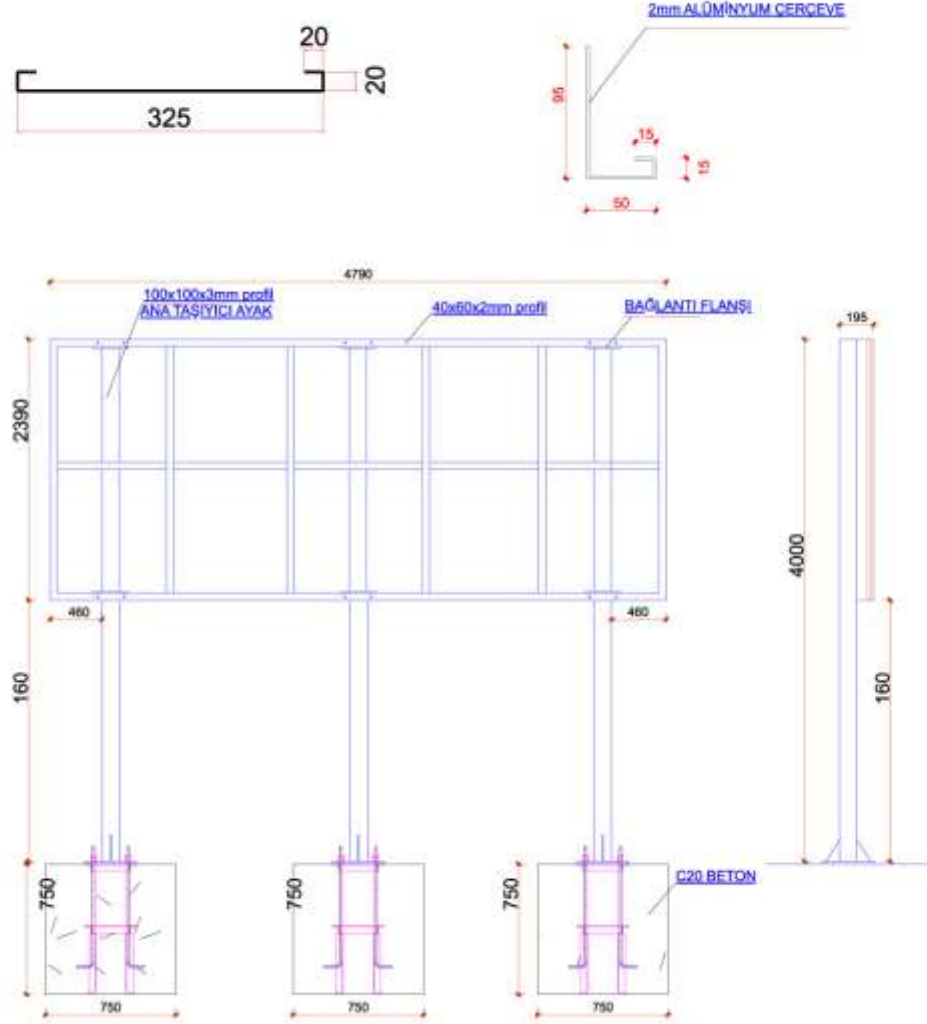

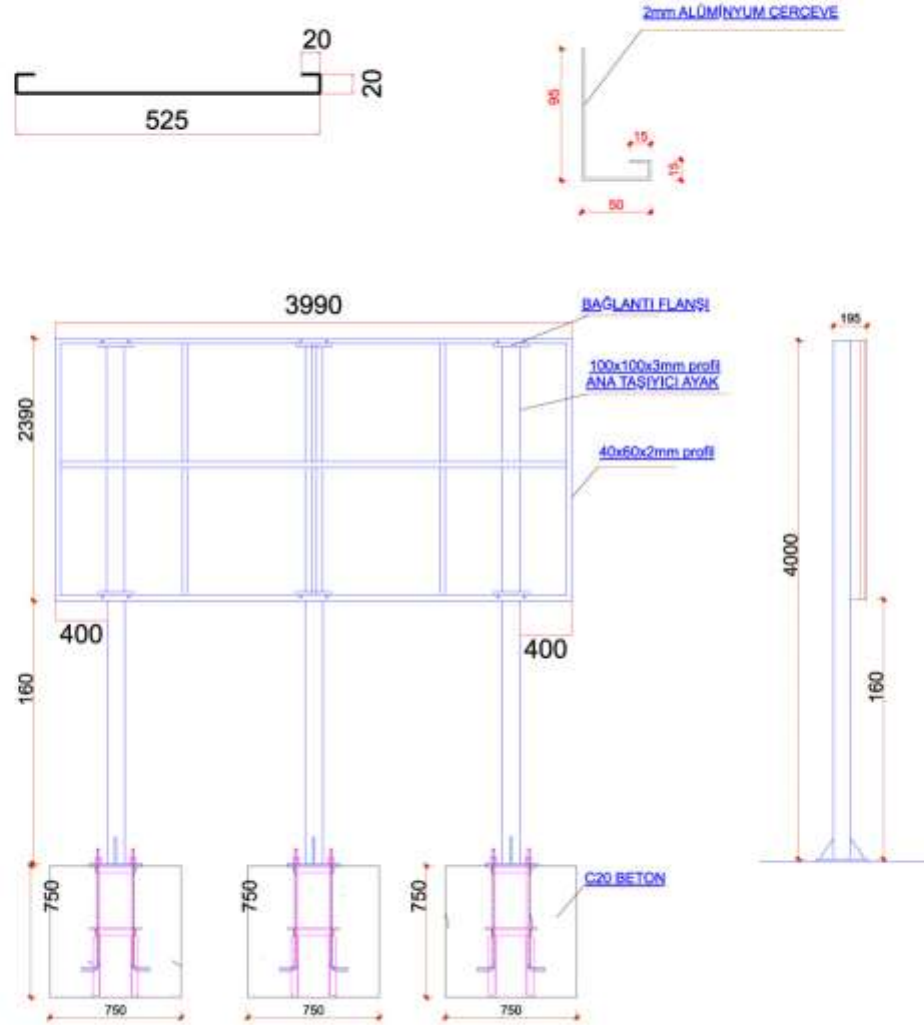

**SOIL-**

İstasyon Görünümler



Bu kurumunai kimlik klavuzunu MTN Reklam tarafından Sijam Petrolcilük A.Ş. için hazırlanmıştır. (Her hakkı saklıdır)





